

siegling belting

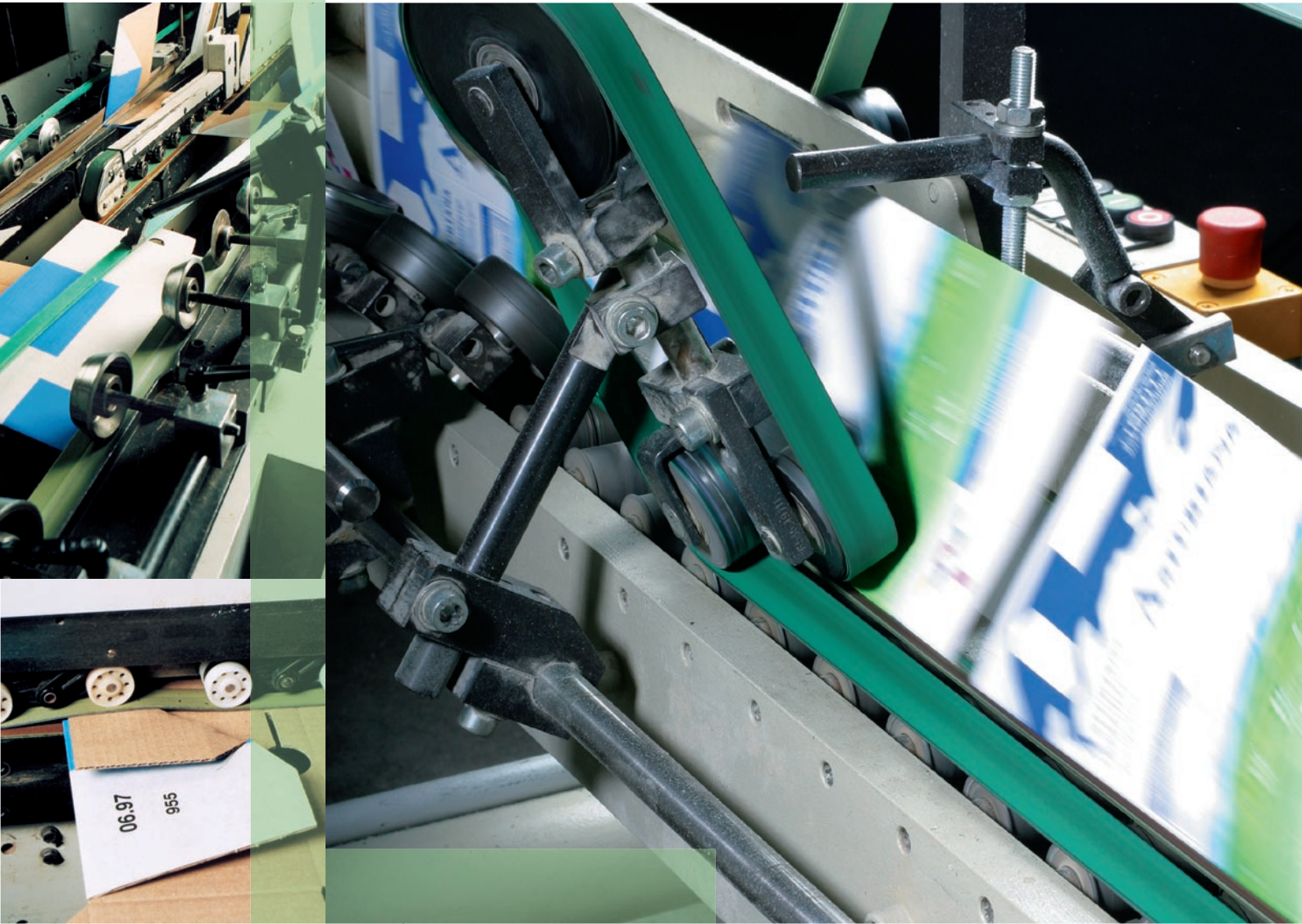

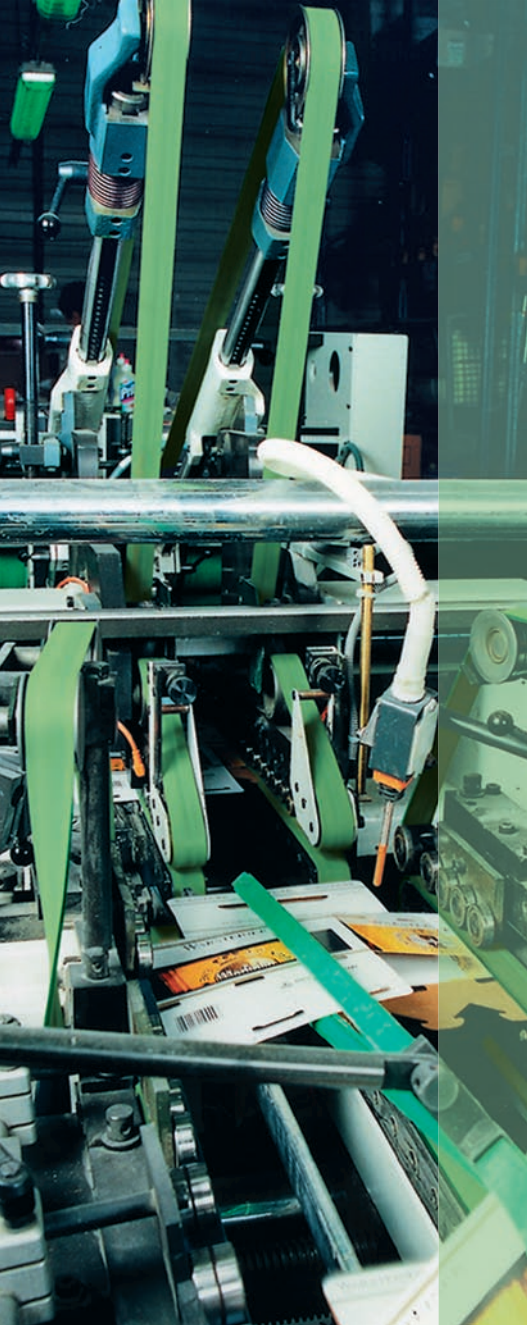

Folder and Carrier Belts

With Forbo Siegling's experience in serving the paper, cardboard and printing industries for decades, we can offer a comprehensive range of folder and carrier belts adapted to particular functions.

With constant friction properties, top faces that protect surfaces, good release and grip properties and long service lives they make a valuable contribution to quality control and efficiency.

The innovative types in the E+A series are the outcome of our research and development work. Due to their aramide or polyester tension member they have low elongation at fitting, are very flexible and not sensitive to fluctuations in ambient conditions.

The splicing method (Z-splice) for these types does not require any additional materials and has the necessary flexibility and durability required for small reversing drums and pulleys.

Easy to handle Z-punch presses and heating clamps make simple fitting directly on the machine possible, reducing the down times.

Thanks to these properties maximum quality and productivity potential from paper processing machinery can be achieved even more easily.

For lead-off and special folder belts the Siegling Linpack product range (ref. no. 244, Linatex coated belts) is available.

Further Forbo Siegling products relevant to the paper industry can be found in the following brochures:

- | | |
|-----|--|
| No. | Title |
| 224 | Product Range Siegling Transilon Conveyor and Processing Belts |
| 225 | Product Range Power Transmission Belts |
| 244 | Product Range Siegling Linpack |
| 271 | Layboy tapes for the printing industry |
| 275 | Layboy tapes for the paper industry and letter sorting |

The Properties

not sensitive to changes in ambient conditions

simple, precise Z-splicing homogenously welded

strong edges

low level of elongation

very flexible

constant friction coefficient with high resistance to abrasion

The Advantages

▶ maintenance free, no re-tensioning, very reliable

▶ short fitting times, no adhesives

▶ durable, long service life

▶ low level of pull on the bearings

▶ small end pulleys, low energy use

▶ safe to use, low operating costs

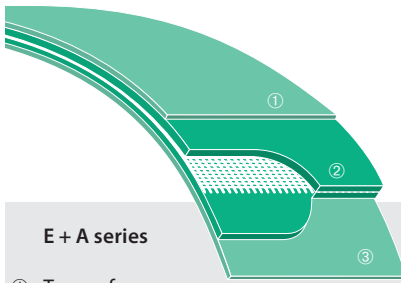

E + A series

- ① **Top surface**
- ③ **Friction coating**
highly abrasion resistant
G elastomer (green), blended
or polyamide fabric, or polyurethane
- ② **Tension member**
E series: thermoplastic, with polyester
fabric in warp and weft

A series: thermoplastic, with highly
modular blended fabric (aramide warp)

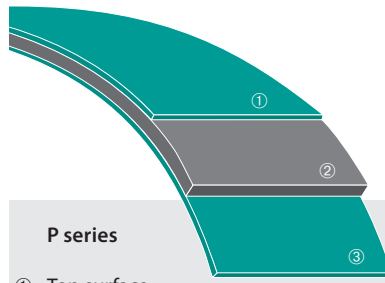

P series

- ① **Top surface**
- ③ **Friction coating**
highly abrasion resistant G elastomer
(green), blended or polyamide fabric
- ② **Tension member**
highly-orientated polyamide belt

Splicing method

Siegling Extremultus folder and carrier belts in the P series are made endless with a bonded wedge splice.

All other types are as a rule made endless with a Z-splice. Forbo Siegling offers an extensive range of easy to handle fitting devices.

Our overview of tools, data sheets and instructions – for Siegling Transilon conveyor and processing belts too – can be obtained on request.

Technical data	Type designation	Article number	Total thickness [mm]	d_{\min} approx. [mm] ¹⁾	$F_{W\text{-value}}$ ²⁾ approx. [N/mm] width	Weight approx. [kg/m ²]
E series (Siegling Extremultus folder and carrier belts with polyester tension member)						
	GG 15E-18 green	822053	1.8	25	15	2.0
	GG 20E-20 green	822052	2.0	30	20	2.3
	GG 20E-30 green	855538	3.0	40	20	3.4
	GG 20E-40 green	855540	4.0	40	20	4.3
	GG 20E-55 green	822050	5.5	50	20	6.0
	GG 30E-32 green	822051	3.2	40	30	3.4
	UU 20E-16 FSTR/FSTR green	822055	1.6	40	20	1.9
	TG 30E-30 black/green	822058	3.0	60	30	3.2
	TG 10E black/green	822081	1.3	20	10	1.4
A series (Siegling Extremultus folder and carrier belts with aramide tension member)						
	UU 15A-17 FSTR/FSTR green	995473	1.7	30	60	1.9
	GG 40A-32 blue	822046	3.2	90	160	3.45
P series (Siegling Extremultus folder and carrier belts with polyamide tension member)						
	GG 6P grey	850007	1.5	30	6	1.7
	GG 10P-30 green	850291	3.0	30	10	3.3
	GG 10P-40 green	850292	4.0	40	10	4.3
	GG 10P-60 green	850293	6.0	50	10	6.0
	GG 14P-20 green	850323	2.0	40	14	2.1
	GG 14P-30 green	850324	3.0	40	14	3.4
	GG 14P-40 green	850325	4.0	40	14	4.6
	GG 14P-50 green	850326	5.0	50	14	5.8
	GG 14P-60 green	850327	6.0	50	14	6.8
	TG 14P-30 black/green	850328	3.0	40	14	3.3
	TG 10P green	995454	1.25	25	10	1.35

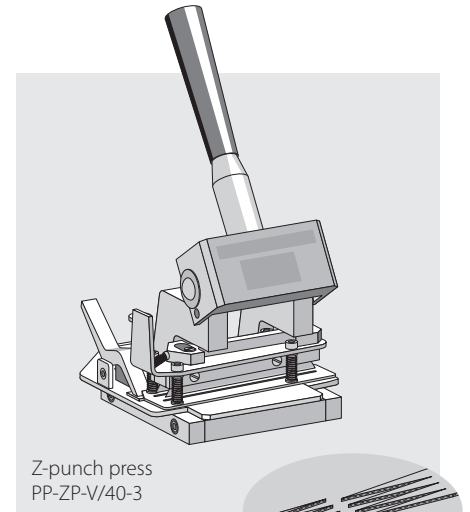

Z-punch press
PP-ZP-V/40-3

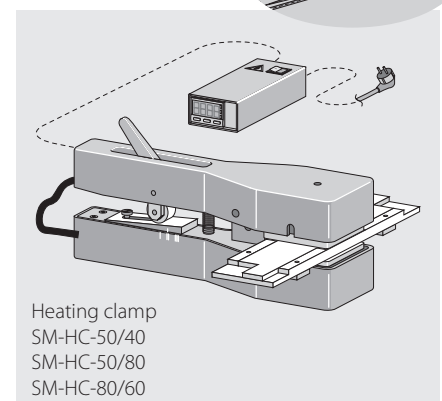

Heating clamp
SM-HC-50/40
SM-HC-50/80
SM-HC-80/60

Key

1) The minimum admissible pulley (roller) diameters have been established under standard ambient conditions. Lower temperatures or particularly low humidity require larger diameters.

2) The $F_{W\text{-value}}$ indicates the shaft load at 1 % elongation in N/mm belt width. It represents a parameter, which in contrast to the ultimate tensile strength, gives a direct indication of the tensile force in the belt.

- A** = aramide
- E** = polyester
- G** = G elastomer
- P** = polyamide
- T** = blended or polyamide fabric

- U** = polyurethane
- FSTR** = fine texture

Siegling – total belting solutions

Committed staff, quality-orientated organisation and production processes ensure the constantly high standards of our products and services. The Forbo Siegling Quality Management System is certified in accordance with DIN EN ISO 9001:2000.

In addition to product quality, environmental protection is an important corporate goal. Early on we also introduced an environmental management system, certified in accordance with ISO 14001.

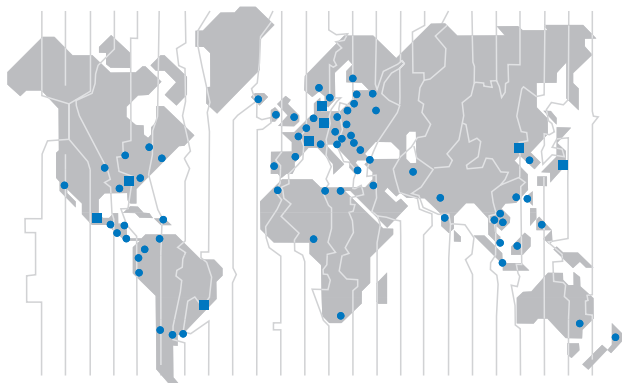

Forbo Siegling Service – anytime, anywhere

In the company group, Forbo Siegling employs more than 1900 people worldwide. Our production facilities are located in eight countries; you can find companies and agencies with stock and workshops in more than 50 countries. Forbo Siegling service centres provide qualified assistance at more than 300 locations throughout the world.