

# Tobacco

## siegling belting





## The properties

belt material of A and E types  
free of halogen and nitrogen

complies with FDA regulations

smooth, hard surfaces

dimensionally stable

light-weight with  
low overall thickness

low elongation



conforms to pyrolysis regulations



A and E types in the range suitable  
for direct contact with tobacco



easy to clean



suitable even at fluctuating  
humidity and temperature



belts are easy to fit,  
low energy consumption



small take-up ranges are possible



# siegling transilon

## Conveyor and processing belts in the Tobacco Industry

**As the worldwide leading manufacturer of conveyor and processing belts of modern synthetics, Forbo Siegling have developed a product range especially suited to the requirements for tobacco processing.**

The Siegling Transilon product range for the tobacco industry is physiologically safe, conforms to pyrolysis regulations (if equipped with an A or E coating), impervious to oils and greases and conforms to the legal regulations for the conveying of unpackaged food.

Our close cooperation with original equipment manufacturers and the tobacco industry ensures that Siegling Transilon, with its chemical and mechanical properties and the extensive range of accessories, meets the requirements for production reliability and productivity.

Siegling Transilon is quick and easy to splice, maintenance-free, simple to track and has a long belt life. Further information about type selection, forms of delivery available and accessories can be found on the following pages.

Numerous other Forbo Siegling products are used in the secondary sector – from the conveying of the individual cigarette to the handling of larger packed units for distribution. These products are presented only briefly in the overview of this brochure. Further information about these is available on request.

### Contents

Primary processing	4
Secondary processing	5
Product range	6
Available as	6
Splice types	6
Patterns	6
Profiles and sidewalls	7



MOVEMENT SYSTEMS



# siegling transilon

## Primary processing

Bales, leaf tobacco, leaf stems, dry or flavoured tobacco: in the numerous stages of processing which tobacco undergoes in the primary process from bale to finished blend, the consistency of the tobacco, the processing temperatures and the conveying tasks are constantly changing.

The Siegling Transilon range has a belt with the right properties to convey the tobacco reliably and smoothly through all stages of the production process.

Since it can never be completely ruled out that particles of the belt surface get into the tobacco due to damage or migration, an ever increasing number of tobacco manufacturers use belts which conform to pyrolysis regulations.



In many cases, conveyor belts equipped with profiles can replace conventional equipment with metal rakes, therefore reducing expensive set-up times.



Various surface patterns (here VN) can be used when conveying at an incline of over 22°.



Conveying with a troughable belt.



Horizontal conveying on a shuttle for the loading of the silo. The belt types with smooth surfaces used here can also be used for inclined conveying up to angles of about 22° (with tobacco moisture of 13 %).



Conveying of bales: extreme punctual loads in stop-and-go operation.

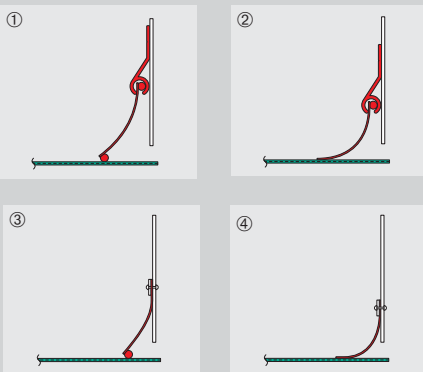

### Efficient skirting:

①②③④ An appropriate skirt belt design depends heavily on the actual operating conditions. Forbo Siegling provide innovative and highly efficient solutions, taking into account customer's specifications.

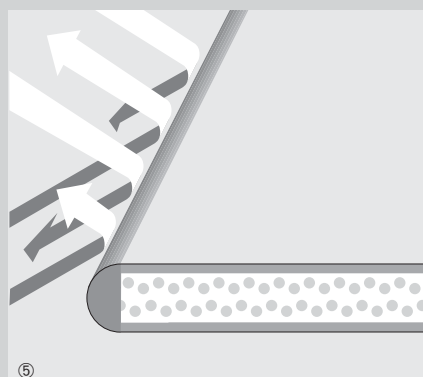

### ProSeal belt-edge sealing:

⑤ Penetration of the belt by moisture and bacteria is prevented by means of sealed belt edges. This sealing process also extends belt life.



### Guaranteed resistance to pyrolysis:

⑥ To be on the safe side for both you the customer and us the developer, we have had the pyrolysis resistance of the corresponding belts in our range certified by an independent institute.



# siegling transilon

## Secondary processing

From the conveying of the individual cigarette to the handling of larger packaged units for distribution: in addition to those belts developed especially for the tobacco industry, numerous other Siegling products are used for the process leading to final dispatch.

Detailed information about these products can be found in the following brochures:

- | No. | Title   |
|-----|---|
| 224 | Siegling Transilon<br>Conveyor and processing belts |
| 266 | Siegling Belting Logistics                          |
| 275 | Siegling Extremultus Layboy tapes                   |
| 245 | Siegling Proposition Timing belts                   |
| 223 | Siegling Prolink Modular belts                      |



Rapid acceleration in stop-and-go operation with extreme punctual loads place high demands on the belts used.



**Straight conveying:** Thanks to an appropriate drag on the belt surfaces, it is possible to convey small packaged units through curves on straight conveyors.

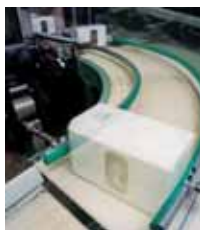

**Curved belts for larger packaged units.**



For the conveying of cigarette packets or cartons, round belts make even complicated conveyor stretches possible.

**siegling proposition**  
timing belts



With various possibilities for coatings and the application of cams and profiles, Siegling Proposition timing belts can be used for varied tasks where form-fit grip is required.

**siegling prolink**  
modular belts

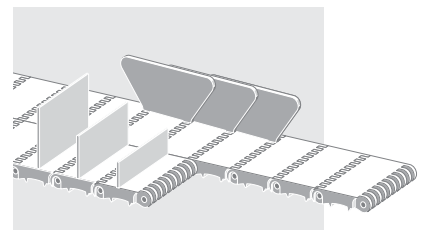

Our Siegling Prolink modular belt range has a variety of uses.

# Product range Tobacco

Technical data, properties and recommendations, possible applications	article number	overall thickness approx. [mm]	weight, approx. [kg/m <sup>2</sup> ]	Effective pull at 1% elongation (k <sub>1%</sub> relaxed) [N/mm width]*	d <sub>min</sub> approx. [mm]**	permissible operating temperatures [°C]	pyrolysis compliant	antistatic finish	patterned	profile possible	belt edge sealing ProSeal possible	KS plastic fastener possible	concave conveyors
<b>Polyester types</b>													
E 3/1 E0/E0 TT	transp.	900339	0.9	0.7	3.5	r 3-8	-30°/+100°	●	●			●	
E 3/1 E2/E2 MT/GL-C-TT	transp.	900340	1.2	1.3	3.5	25	-30°/+100°	●	●	●		●	●
E 8/2 E0/E0 TT <sup>1)</sup>	transp.	900342	1.3	1.2	6.5	25	-30°/+100°	●	●		●	●	●
E 10/2 E0/E10 VN-TT	transp.	900343	4.4	3.3	13	60	-30°/+100°	●	●	●		●	●
E 12/2 E0/E3 MT-TT	transp.	900348	1.7	1.8	12	50	-30°/+100°	●	●		●	●	
E 12/2 E3/E3 STR/MT-TT	transp.	900349	2.2	2.5	14	50	-30°/+100°	●	●		●	●	○
E 18/3 E0/E3 MT-TT	transp.	900350	2.6	2.8	16	60	-30°/+100°	●	●		●	●	
E 18/3 E0/E10 VN-TT <sup>1)</sup>	transp.	906494	4.8	4.1	14	90	-30°/+100°	●	●	●			
E 18/3 E3/E10 MT/VN-TT <sup>1)</sup>	transp.	900351	5.2	4.5	14	90	-30°/+100°	●	●	●			
<b>Polyolefin types</b>													
E 6/2 0/A3 TT <sup>1)</sup>	transp.	900341	1.3	1.3	4	(60)90	-10°/+60°	●	●				●
E 9/2 A5/A5 NP/GL-TT	transp.	900346	3.5	3.0	4.5	90	-10°/+60°	●	●				○
E 9/2 A0/A15 VN-TT	transp.	900344	4.8	3.3	4.5	90	-10°/+60°	●	●	●			
E 10/2 E0/A5 TT	transp.	906505	2.6	2.4	11	(60)90	-10°/+60°	●	●		●		○
E 12/2 A0/A3 MT-TT	green	900347	1.8	1.8	14	60	-10°/+80°	●	●		●	●	●
E 12/2 A0/A3 MT-TT	transp.	906583	1.8	1.8	14	60	-10°/+80°	●	●		●	●	●
E 2/1 A2/A2-NA-TT	blue	900360	0.8	0.7	-	-	-10°/+60°	●					
E 2/1 A2/A2-NA-TT	beige	900361	0.8	0.7	-	-	-10°/+60°	●					
N/A4 <sup>1)</sup>	transp.	906312	1.1	1.0	-	-	-10°/+60°	●					
<b>PVC and PU coating</b>													
E 3/1 U0/U2 MT-C-HACCP	white	900008	0.7	0.7	2	r 3-8	-30°/+100°		●			●	●
E 12/2 V5/V10 STR/GL	green	900053	3.3	3.9	14	60	-10°/+70°		●		●	●	●
E 8/2 U0/V20 KN	green	900139	3.6	3.2	8	60	-10°/+70°		●			●	●
E 10/M V1/V10	white	900092	2.9	3.3	9	60	-10°/+70°		●		●	●	●
E 12/2 U0/UH	green	900043	1.5	1.5	14	(40)60	-30°/+100°		●		●	●	
E 18/3 U0/V20	green	900088	4.8	5.7	21	120	-10°/+70°		●		●	●	○
E 12/2 U0/U0	transp.	900040	1.4	1.4	6.5	60	-30°/+100°		●		●	●	

The Siegling Transilon range is constantly updated to include innovative developments, custom-engineered for the market.

## Available as

- endless belts
- open belts prepared for melt- and bonded splices on site
- roll material for customer to finish
- belts with mechanical fastener
- belts with edge sealing (ProSeal)
- belts with welded profiles (longitudinal, lateral or diagonal)

Profiles as roll material are also available.

## Splice types

The hot-pressed stepped Z-splice, which is a standard for endless belts, meets the highest requirements for uniformity of thickness and mechanical stability. (fig. ①).

Various mechanical fasteners can be used to facilitate belt replacement and repairs without requiring the conveyor to be dismantled. (fig. ② ③ ④).

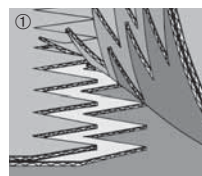

Stepped Z-splice

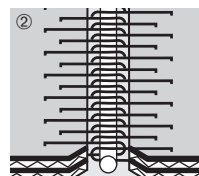

Wire hook fastener

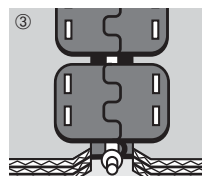

Clamp fastener

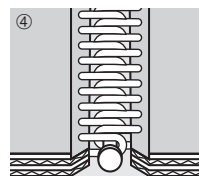

Plastic fastener

## Patterns

In many cases, patterned belts are an affordable alternative to welded-on profiles.

- particularly good grip
- easy to clean
- smooth belt run, low noise

Especially when combined with side skirts, the VN pattern can be peeled off at the belt edges. (see fig. below)

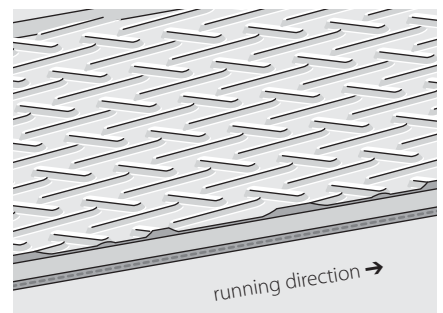

Staggered stud (VN) peeled off at belt edges (scale 1:5)

Uses	swan-neck conveyors	inclined conveyors	machinery with scrapers	skirt belt	curtain or covering material	conveying of tobacco bales	checkweigher	heavily flavoured tobacco	silos belts (with chain drive)	silos belts (without chain drive) feeder belts
			●	●	●		●		●	
			●				●		●	
	○	●	●			●	●	●		●
	○		●			●	●		●	●
	●	●	●			●				●
	●	●								
		●					●	●		●
			●			●		●		●
	○		●			●	●	●		●
	○		●			●	●	●		●
				●	●					
		●	●			●	●			●
			●			●		●		
			●			●				●
			●			●	●			●

## siegling transilon

conveyor and processing belts

### Legend

\* Established in line with ISO 21181:2005

\*\* Minimum drum diameters were determined at room temperature and do not apply to conveyor belts with mechanical fasteners. Lower temperatures require larger drum diameters. Belts with profiles or sidewalls may require larger drum diameters. Please see brochure ref. no. 318, Siegling Transilon Technical Information 2.

1) Delivery periods on request.

- = Yes
- = On request

**C** = Laterally flexible, suitable for curved belt

**GL** = Smooth surface

**KN** = Cross-stud pattern

**MT** = Matt surface

**NP** = Inverted pyramid pattern

**STR** = Normal textured pattern

**VN** = Staggered stud pattern

**TT** = Pyrolysis compliant

### Profiles and Sidewalls

In many cases, conveyor belts equipped with profiles can replace conventional equipment with metal rakes, therefore reducing expensive set-up times. Profiles are available in various sizes, and also available as roll material.

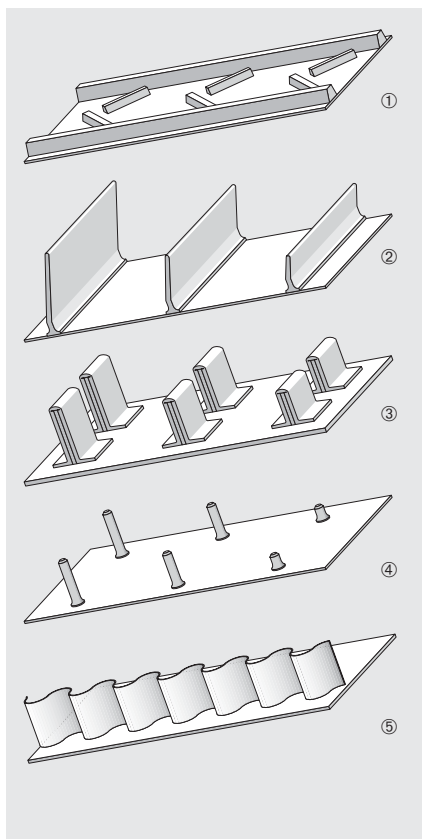

- ① K profiles (can also be used as lateral profiles)
- ② L profiles/T profiles (10–60 mm height)
- ③ Loop profiles
- ④ Rake profiles
- ⑤ Corrugated sidewalls

### Type designation for Siegling Transilon Conveyor and processing belts

**E 8 / 2 U0 / V20 KN green**



MOVEMENT SYSTEMS

## Siegling – total belting solutions

Committed staff, quality-orientated organisation and production processes ensure the constantly high standards of our products and services. The Forbo Siegling Quality Management System is certified in accordance with DIN EN ISO 9001:2000.

In addition to product quality, environmental protection is an important corporate goal. Early on we also introduced an environmental management system, certified in accordance with ISO 14001.

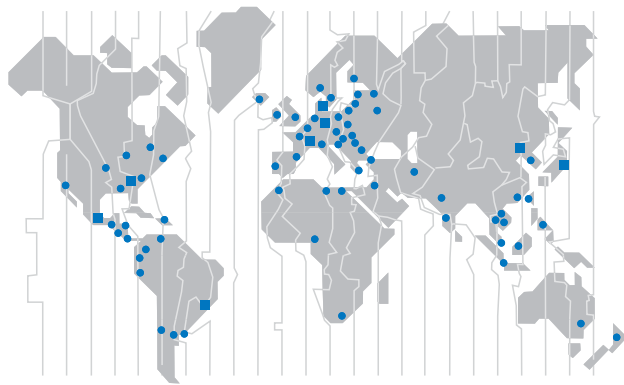

### Forbo Siegling Service – anytime, anywhere

In the company group, Forbo Siegling employs more than 1900 people worldwide. Our production facilities are located in eight countries; you can find companies and agencies with stock and workshops in more than 50 countries. Forbo Siegling service centres provide qualified assistance at more than 300 locations throughout the world.